

High End / Low Cost Pulsed Laser Diodes 905D1 SxxUA-Series

Features

- Single and multi-junction devices up to 110 W
- Hermetic 5.6 mm CD package
- Excellent temperature stability
- Ultra precise mechanical tolerances
- Fully RoHS compliant

Applications

- Range finding
- Surveying equipment
- Weapons simulation
- Laser radar
- Obstacle detection
- Medical
- Automotive



Optical Characteristics at $t_{RT} = 21^{\circ}\text{C}$

	Min	Typ	Max	Units
Wavelength of peak radiant intensity λ	895	905*	915	nm
Spectral bandwidth $\Delta\lambda$ at 50% intensity points		8		nm
Wavelength temperature coefficient		0.27		nm/ $^{\circ}\text{C}$
Beam spread (50% peak intensity)				
Parallel to junction plane \parallel		12		Degrees
Perpendicular to junction plane \perp		20		Degrees

*Custom version could be adjusted to 895 nm \pm 10 nm

Optical Characteristics at $t_{RT}= 21\text{ }^{\circ}\text{C}$, $t_w= 150\text{ ns}$, $P_{rr}= 6.66\text{ kHz}$

Parameter	905D1S03UA	905D1S09UA	905D1S3J03UA	905D1S3J06UA*	905D1S3J09UA	905D1S3J12UA*	Units
P_o at I_{FM} (min)	6.5	19	27	52	80	110	W
Emitting area	75 x 1	230 x 1	85 x 10	160 x 10	235 x 10	310 x 10	μm
Max. peak current I_{FM} at 150 ns t_w	7	22	11	22	35	45	A
Threshold I_{th}	250	750	500	650	800	1000	mA
Forward voltage at I_{FM}	3	4.7	9.5	11.75	12.8	12	V

* only available on request!

Absolute Maximum Ratings

Maximum ratings	Limiting values
Peak reverse voltage	6 V
Pulse duration	1 μs
Duty factor	0.1%
Temperature* - Storage - Operating	-55 $^{\circ}\text{C}$ to +100 $^{\circ}\text{C}$ -45 $^{\circ}\text{C}$ to +85 $^{\circ}\text{C}$
Lead soldering* - 5 seconds max at	260 $^{\circ}\text{C}$

* can be adjusted for automotive

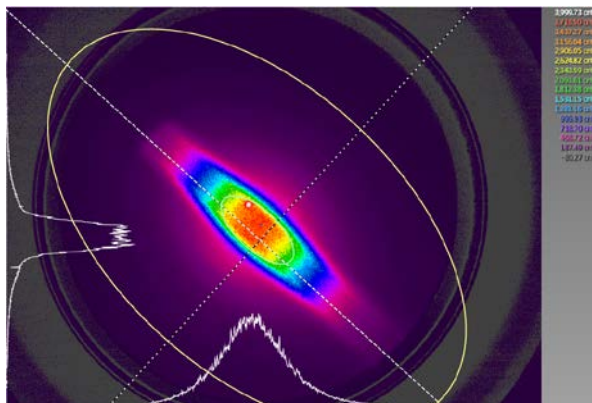

Typical far field scan of triple junction lasers

Figure 1a: Optical Output Power vs. Forward Current (single junction units)

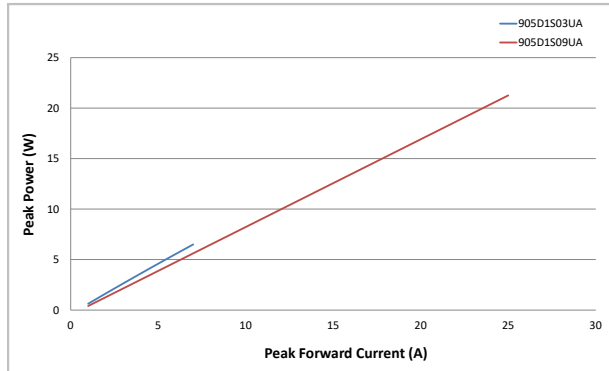

Figure 1b: Optical Output Power vs. Forward Current (triple junction units) – 1S3J03 – 1S3J09

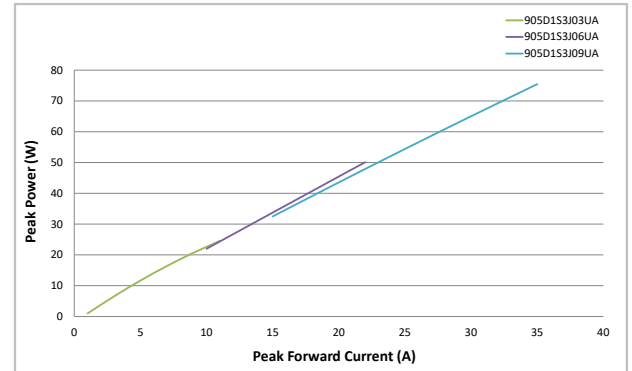

Figure 1c: Optical Output Power vs. Forward Current (905D1S3J12UA)

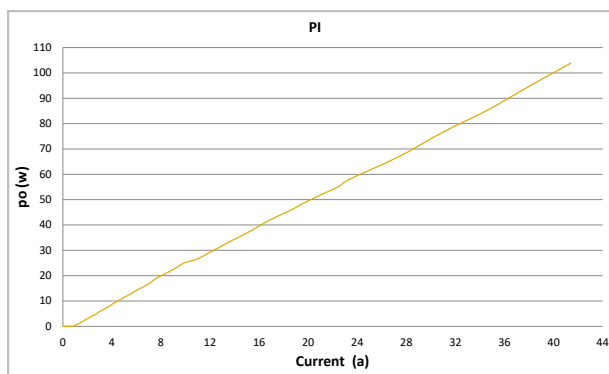

Figure 2: Optical Output Power vs. Temperature

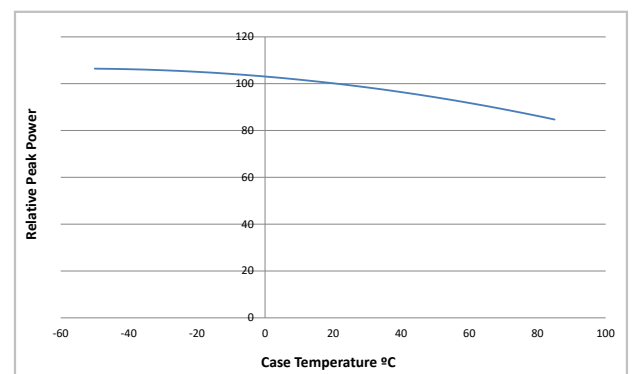

Figure 3: Optical Output Power vs. F#

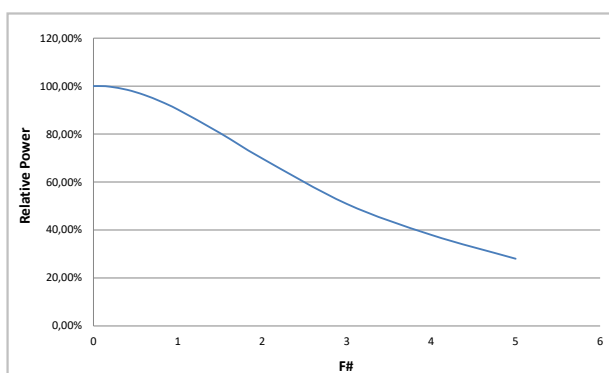

Figure 4: Wavelength vs. Temperature

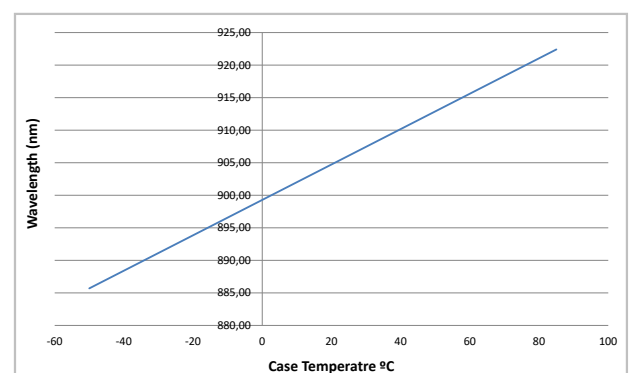

Figure 5: Typical Spectral Plot

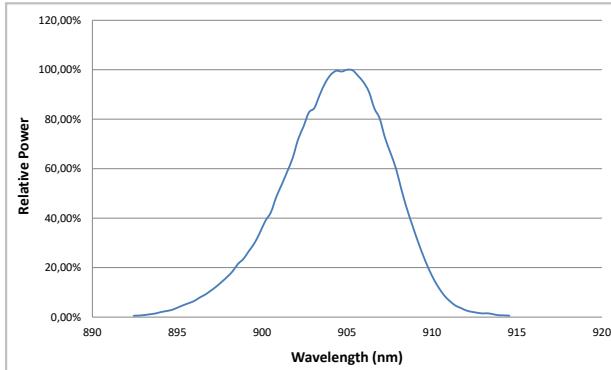

Figure 6a: Static Forward Voltage vs. Current

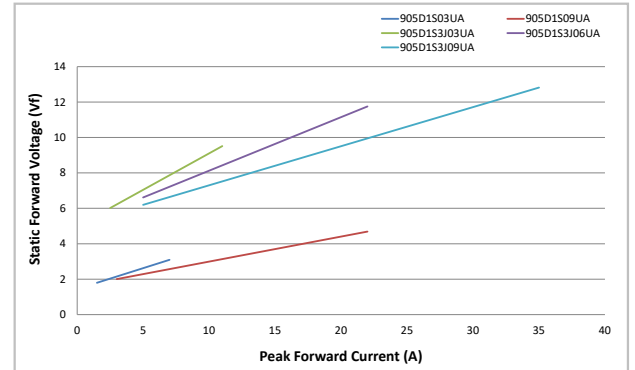
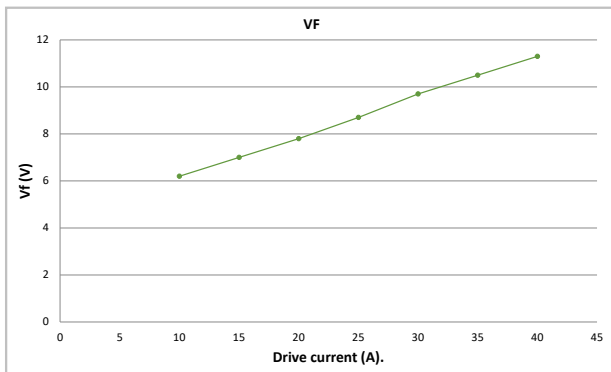
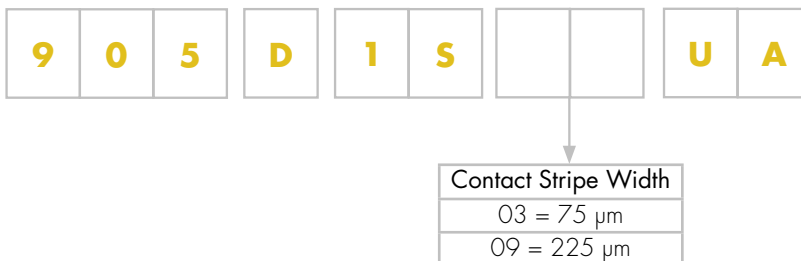

Figure 6b: Static Forward Voltage vs. Current
(905D1S3J12UA)



Product Number Designations (Single element devices)



Product Number Designations (Multi junction devices)



Contact Stripe Width

03	=	85 μm
06	=	160 μm
09	=	236 μm
12	=	310 μm

Package Drawings

Package UA 5.6 mm CD

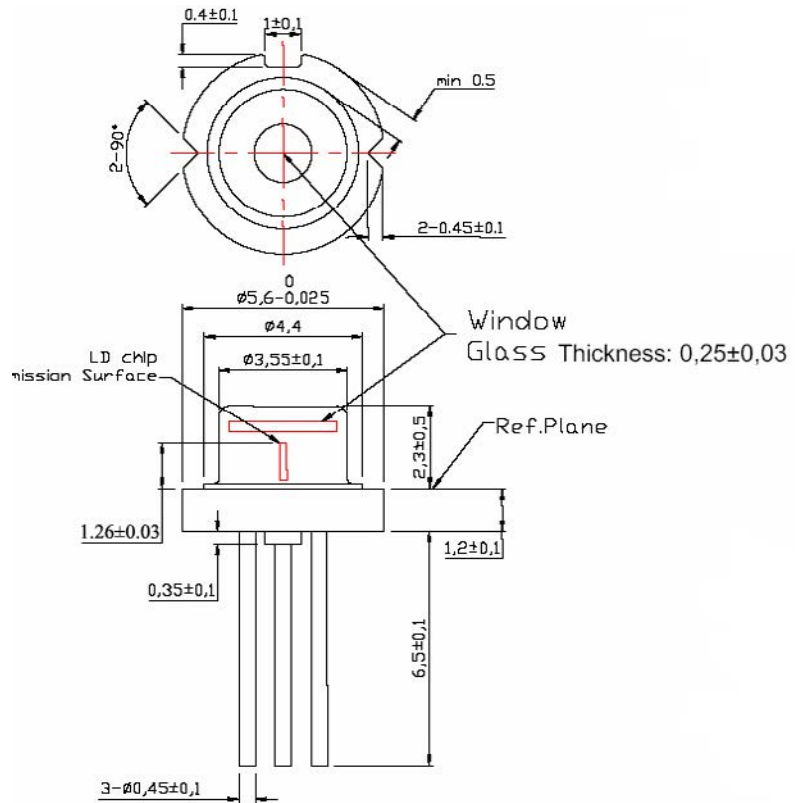

Bottom View :

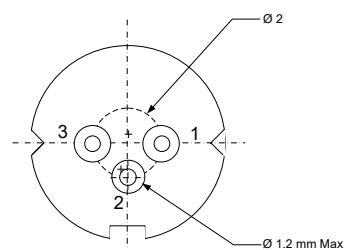

Package U Pin Out : 1. LD Anode(+)
2. LD Cathode(-) Case
3. NC
Inductance 5.0 nH

Die Placement Accuracy

Measuring Point		Tolerance
LD	ΔX	$0 \pm 50 \mu\text{m}$
	ΔY	$0 \pm 50 \mu\text{m}$
	ΔZ	$1260 \pm 30 \mu\text{m}$
	$\Delta\theta$	$0 \pm 2^\circ$

Die Placement Accuracy

Measuring Point		Tolerance
Cap	X	$0 \pm 100 \mu\text{m}$
	Y	$0 \pm 100 \mu\text{m}$

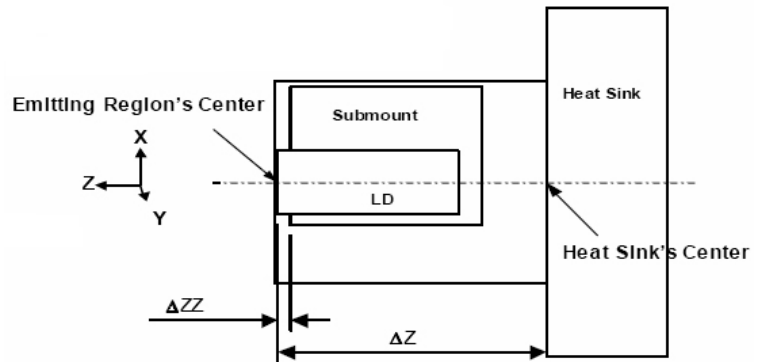
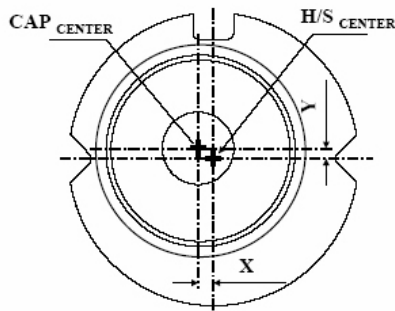

Product Changes

LASER COMPONENTS reserves the right to make changes to the product(s) or information contained herein without notice. No liability is assumed as a result of their use or application.

Ordering Information

Products can be ordered directly from LASER COMPONENTS or its representatives. For a complete listing of representatives, visit our website at www.lasercomponents.com

Custom designed products are available on request.

Laser Safety

Personal Hazard:

Depending on the mode of operation, these devices emit highly concentrated non visible infrared light which can be hazardous to the human eye. Products which incorporate these devices have to follow the safety precautions given in IEC 60825-1 "Safety of laser products".

Handling Precautions:

Products are subject to the risks normally associated with sensitive electronic devices including static discharge, transients, and overload.